

**8-/16-/24-Port 10/100TX 802.3at PoE+
Gigabit TP/SFP Ethernet Switch with Smart LCD**

FGSD-1022VHP/FGSW-1822VHP/FGSW-2622VHP

User's Manual

Copyright

Copyright © 2021 by PLANET Technology Corp. All rights reserved. No part of this publication may be reproduced, transmitted, transcribed, stored in a retrieval system, or translated into any language or computer language, in any form or by any means, electronic, mechanical, magnetic, optical, chemical, manual or otherwise, without the prior written permission of PLANET.

PLANET makes no representations or warranties, either expressed or implied, with respect to the contents hereof and specifically disclaims any warranties, merchantability or fitness for any particular purpose. Any software described in this manual is sold or licensed "as is". Should the programs prove defective following their purchase, the buyer (and not PLANET, its distributor, or its dealer) assumes the entire cost of all necessary servicing, repair, and any incidental or consequential damages resulting from any defect in the software. Further, PLANET reserves the right to revise this publication and to make changes from time to time in the contents hereof without obligation to notify any person of such revision or changes.

All brand and product names mentioned in this manual are trademarks and/or registered trademarks of their respective holders.

Trademarks

PLANET is a registered trademark of PLANET Technology Corp. All other trademarks belong to their respective owners.

Disclaimer

PLANET Technology does not warrant that the hardware will work properly in all environments and applications, and makes no warranty and representation, either implied or expressed, with respect to the quality, performance, merchantability, or fitness for a particular purpose.

PLANET has made every effort to ensure that this User's Manual is accurate; PLANET disclaims liability for any inaccuracies or omissions that may have occurred. Information in this User's Manual is subject to change without notice and does not represent a commitment on the part of PLANET. PLANET assumes no responsibility for any inaccuracies that may be contained in this User's Manual. PLANET makes no commitment to update or keep current the information in this User's Manual, and reserves the right to make improvements to this User's Manual and/or to the products described in this User's Manual, at any time without notice. If you find information in this manual that is incorrect, misleading, or incomplete, we would appreciate your comments and suggestions.

FCC Interference Statement

This equipment has been tested and found to comply with the limits for a Class A digital device, pursuant to Part 15 of the FCC Rules. These limits are designed to provide reasonable protection against harmful interference when the equipment is operated in a commercial environment. This equipment generates, uses, and can radiate radio frequency energy and, if not installed and used in accordance with the Instruction manual, may cause harmful interference to radio communications. Operation of this equipment in a residential area is likely to cause harmful interference in which case the user will be required to correct the interference at his own expense.

CE Mark Warning

This is a Class A product. In a domestic environment, this product may cause radio interference, in which case the user may be required to take adequate measures.

WEEE Warning



To avoid the potential effects on the environment and human health as a result of the presence of hazardous substances in electrical and electronic equipment, end users of electrical and electronic equipment should understand the meaning of the crossed-out wheeled bin symbol. Do not dispose of WEEE as unsorted municipal waste; WEEE should be collected separately.

Revision

PLANET 8-/16-/24-Port 10/100TX 802.3at PoE+ SFP Ethernet Switch with Smart LCD User's Manual

Models: FGSD-1022VHP, FGSW-1822VHP, FGSW-2622VHP

Revision: 3.2 (October. 2021)

Part No.: 2351-AK5040-005

Table of Contents

1. Introduction	5
1.1 Package Contents	5
1.2 Product Description.....	6
1.3 Features	10
1.4 Specifications	12
2. Hardware Description.....	15
2.1 Front Panel	15
2.1.1 LCD Monitor Indicators	16
2.1.2 LED Indicators	17
2.2 Rear Panel	19
2.3 LCD Management	20
2.3.1 Switch Mode.....	21
2.3.2 Budget Control.....	23
2.3.3 PSE Port Priority.....	23
2.3.4 PSE Port Enable	24
2.3.5 PD Type	24
2.3.6 Alive Check.....	25
2.3.7 Bandwidth Detection.....	26
2.3.8 Fan Control.....	26
2.3.9 Screen Saver	26
2.3.10 Language	27
2.3.11 Default Setting.....	27
2.3.12 System	27
3. Hardware Installation	28
3.1 Desktop Installation.....	29
3.2 Rack Mounting	30
3.3 Installing the SFP Transceiver	31
3.4 Product Applications.....	33
3.5 Power over Ethernet Powered Devices.....	34
4. Power over Ethernet Overview	35
5. Troubleshooting	38

1. Introduction







Thank you for purchasing PLANET 8/16/24-Port 10/100TX 802.3at PoE+ SFP Ethernet Switch series, FGSD-1022VHP, FGSW-1822VHP and FGSW-2622VHP. The descriptions of these models are shown below:

- FGSD-1022VHP 8-Port 10/100TX 802.3at PoE + 2-Port Gigabit TP/SFP Combo Desktop Switch with LCD PoE Monitor
- FGSW-1822VHP 16-Port 10/100TX 802.3at PoE + 2-Port Gigabit TP + 2-Port SFP Ethernet Switch with LCD PoE Monitor
- FGSW-2622VHP 24-Port 10/100TX 802.3at PoE + 2-Port Gigabit TP + 2-Port SFP Ethernet Switch with LCD PoE Monitor

“802.3at PoE+ Switch” is used as an alternative name in this user’s manual.

1.1 Package Contents

Open the box of the 802.3at PoE+ Switch and carefully unpack it. The box should contain the following items:

802.3at PoE+ Switch x 1	User’s Manual x 1
	
Power Cord x 1	Rubber Feet x 4
	
Rack-mounting Brackets x 2	Screws Package x 1
	

If any of these pieces are missing or damaged, please contact your dealer immediately; if possible, retain the carton including the original packing material, and use them again to repack the product in case there is a need to return it to us for repair.

1.2 Product Description

Ideal High-performance Integration Solution for Secure IP Surveillance Infrastructure

Particularly designed for the growing popular IP surveillance applications, PLANET FGSD/FGSW 802.3at PoE+ Switch series is positioned as a surveillance switch with the central power management and IP camera monitoring.

The FGSD/FGSW 802.3at PoE+ Switch series brings an ideal, secure surveillance system at a lower total cost. The FGSD/FGSW 802.3at PoE+ Switch series provides multiple 10/100 Mbps 802.3at/af PoE ports able to supply sufficient PoE power to IEEE 802.3at PoE IP cameras at the same time. It is also able to be connected with an 8-/16-/32-channel NVR system, uplinked to the backbone switch and the monitoring center. With such high-performance switch architecture, the recorded video files from the PoE IP cameras can be saved in the NVR system to enable the administrators to control and monitor the surveillance images both in the local LAN and the remote sites.

Model	FGSD-1022VHP	FGSW-1822VHP	FGSW-2622VHP
10/100TX Copper	8 x RJ45	16 x RJ45	24 x RJ45
10/100/1000T Copper	2 x RJ45 (Combo)	2 x RJ45	2 x RJ45
1000X Fiber Optic	2 x SFP Slots (Combo)	2 x SFP Slots	2 x SFP Slots
802.3af/at PoE+ Ports	8	16	24
PoE Budget	120 watts	300 watts	300 watts
Enclosure	12" metal case	19" metal case	19" metal case

Just "Plug and Watch" for a Quick Solution

The FGSD/FGSW 802.3at PoE+ Switch series is an ideal Plug and Watch Power over Ethernet solution which provides quick installation, real-time PoE work status monitoring and immediate troubleshooting through its unique LCD display to improve work efficiency and quality without any PC or software required.

The FGSD/FGSW 802.3at PoE+ Switch series is equipped with 8/16/24 10/100BASE-TX ports featuring 30-watt 802.3at Power over Ethernet Plus (PoE+) copper interfaces. With a total PoE power budget of up to 120/300 watts and non-blocking data switching performance, the FGSD/FGSW 802.3at PoE+ Switch series fulfills the demand of sufficient PoE power for HD IP surveillance. It offers a desktop-sized, reliable and visible power solution for small businesses and system integrators deploying Power over Ethernet networks.

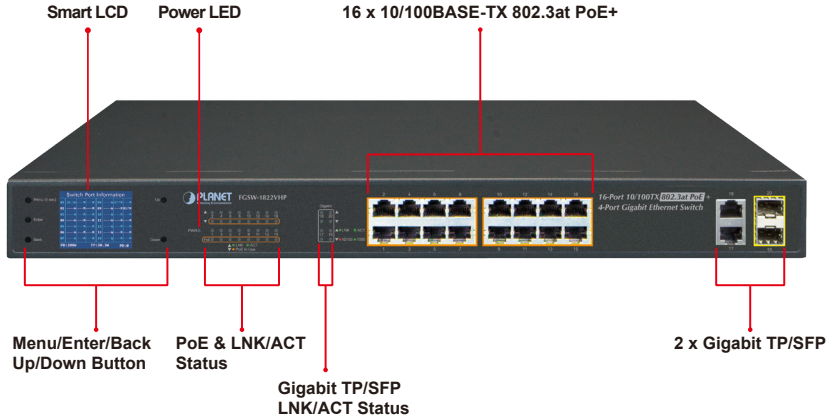

Smart and Intuitive LCD Control

The FGSD/FGSW 802.3at PoE+ Switch series provides an intuitive color panel on its front panel that facilitates the Ethernet management and PoE PD management. They greatly promote management efficiency in large-scale network, such as enterprises, hotels, shopping malls, government buildings and other public areas, and feature the following special management and status functions:

- PoE management and status
- Port management and status
- Switch Mode: Standard, VLAN, Extend
- Budget and bandwidth control
- PD alive check
- Maintenance: Screen saver, fan control, factory default and save configuration

Switch Port Information					
01	30.3W	--M	-33M	08	---W ---M ---M
02	---	W	---	09	-8.3W ---M -11M
03	---	W	---	10	---W ---M ---M
04	15.4W	-10M	---	11	-OFF- ---M ---M
05	---	W	---	12	---W ---M ---M
06	---	W	---	13	17.6W -11M -12M
07	---	W	---	14	---W ---M ---M
PB:300W		TP:72W		PD:4	

Main Menu	
01	- Switch Mode
02	- Budget Control
03	- PSE Port Priority
04	- PSE Port Enable
05	- PD Type
06	- Alive Check
07	- Bandwidth
08	- Fan Control

Switch Mode	
Options:	
>	Standard
	VLAN
	Extend

PSE Port Enable	
Port	Status
01	> Enable
	Disable
Current Setting: Enable	
<UP>/<Down>:Select	
<Enter>:Confirm <Back>:Return	



Standard, VLAN and Extend Operation Modes Offered

The FGSD/FGSW 802.3at PoE+ Switch series provides Standard, VLAN and Extend operation modes. The FGSD/FGSW 802.3at PoE+ Switch series operates as a normal IEEE 802.3af/at PoE Switch in the Standard operation mode.

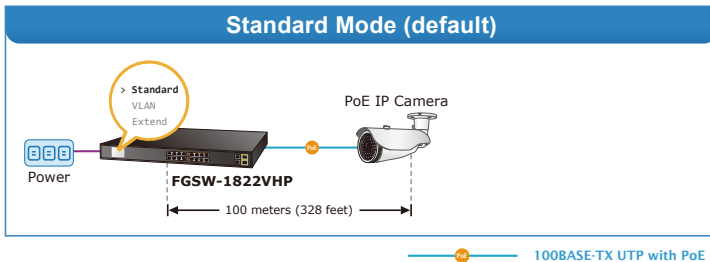

The VLAN operation mode features the port-based VLAN function that can help to prevent the IP camera's multicast or broadcast storm from influencing each other.

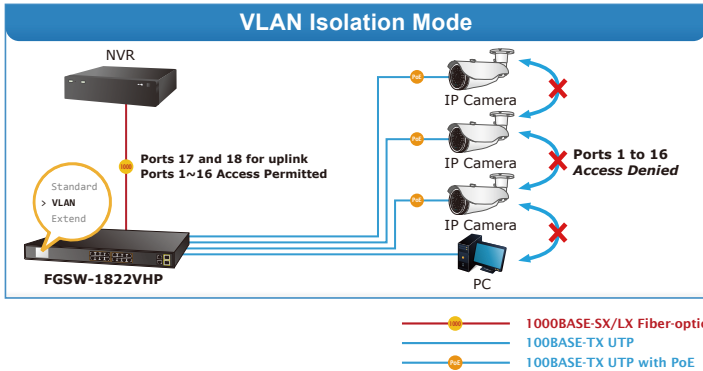

In the Extend operation mode, the FGSD/FGSW 802.3at PoE+ Switch series operates on a per-port basis at 10Mbps duplex operation but can support 20-watt PoE power output over a distance of up to 250 meters overcoming the 100m limit on Ethernet UTP cable. With this brand-new feature, the FGSD/FGSW Series provides an additional solution for 802.3af/at PoE distance extension, thus saving the cost of Ethernet cable installation. Its VLAN isolation function isolates ports so as to prevent broadcast storm and defend DHCP spoofing in the Extend operation mode.

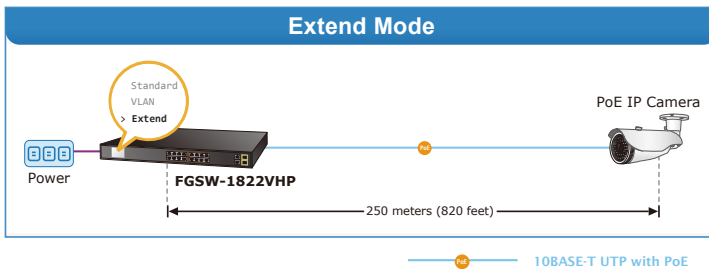

Flexible Extension Solution

The two mini-GBIC slots built in the FGSD/FGSW 802.3at PoE+ Switch series are compatible with the 1000BASE-SX/LX SFP (Small Form-factor Pluggable) fiber transceiver, uplinked to the backbone switch and monitoring center in long distance. The distance can be extended from 550 meters (multi-mode fiber) to 10/20/40/80/120 kilometers (single-mode fiber or WDM fiber). They are well suited for applications within the enterprise data centers and distributions.

Robust Protection

The FGSD/FGSW 802.3at PoE+ Switch series provides contact discharge of $\pm 4/6\text{KV}$ DC and air discharge of $\pm 6/8\text{KV}$ DC for Ethernet ESD protection. It also supports $\pm 4/6\text{KV}$ surge immunity to improve product stability and protects users' networks from devastating ESD attacks, making sure the flow of operation does not fluctuate.

Easy Installation and Cable Connection

As data and power are transmitted over one cable, the FGSD/FGSW 802.3at PoE+ Switch series does not need a second cable and electrical outlets on the wall, ceiling or any unreachable place. Thus, it helps to lower the installation costs and simplify the installation effort. All the RJ45 copper interfaces of the FGSD/FGSW 802.3at PoE+ Switch series support 10/100/1000Mbps auto-negotiation for optimal speed detection through RJ45 Category 6, 5 or 5e cable. It also supports standard auto-MDI/MDI-X that can detect the type of connection to any Ethernet device without requiring special straight-through or crossover cables.

1.3 Features

➤ Physical Port

FGSD-1022VHP

- 8-port 10/100BASE-TX Fast Ethernet Gigabit RJ45 copper
- 2 10/100/1000BASE-T TP and 2 1000BASE-X mini-GBIC SFP shared combo interfaces

FGSW-1822VHP

- 16-port 10/100BASE-TX Fast Ethernet RJ45 copper
- 2 10/100/1000BASE-T TP and 2 1000BASE-X mini-GBIC SFP interfaces

FGSW-2622VHP

- 24-port 10/100BASE-TX Fast Ethernet RJ45 copper
- 2 10/100/1000BASE-T TP and 2 1000BASE-X mini-GBIC SFP interfaces

➤ Power over Ethernet

- Complies with IEEE 802.3af/at Power over Ethernet end-span PSE
- Up to 8/16/24 ports of IEEE 802.3af/at devices powered
- Supports PoE Power up to 30 watts for each PoE port
- Each port supports 54V DC power to PoE powered device
- 120-watt PoE budget (FGSD-1022VHP)
- 300-watt PoE budget (FGSW-1822VHP/FGSW-2622VHP)

- Auto detects powered device (PD)
- Circuit protection prevents power interference between ports
- Remote power feeding up to 100m in standard mode and 250m in extend mode

➤ **Smart LCD**

- The LCD switch features “**Standard**”, “**VLAN**” and “**Extend**” mode selection; the “**Extend**” mode features 20-watt PoE transmission distance of 250m at speed of 10Mbps and VLAN isolation
- The LCD switch is able to isolate ports to prevent broadcast storm and defend DHCP spoofing
- Power low-voltage, power over-voltage and PSE over-temperature protection
- Screen saver, fan control, factory default and save configuration
- PoE management
 - Total PoE power budget control
 - Per port PoE function enable/disable
 - PoE port power feeding priority
 - Per PoE port power limitation
 - PD alive check

➤ **Switching**

- Hardware-based 10/100/1000Mbps auto-negotiation and auto MDI/MDI-X
- Flow control for full duplex operation and back pressure for half duplex operation
- 9216/16K bytes packet size
- Integrates address look-up engine, supporting 8K/16K absolute MAC addresses
- IEEE 802.1Q VLAN transparency
- Automatic address learning and address aging

➤ **Hardware**

- 12/19-inch desktop size, 1U height, rack mountable
- 2-inch color LCD with smart management functions
- LED indicators for system power, per port PoE ready and PoE activity, speed, Link/Act
- 1/3 silent fans to provide stable and efficient power performance
- Supports Energy-Efficient Ethernet (EEE) function (IEEE 802.3az)
- Supports contact discharge of $\pm 4/6$ KV DC and air discharge of $\pm 6/8$ KV DC for Ethernet ESD protection
- Supports $\pm 4/6$ KV surge immunity

1.4 Specifications

Model	FGSD-1022VHP	FGSW-1822VHP	FGSW-2622VHP
Hardware Specifications			
802.3af/at PoE Injector Port	8	16	24
10/100BASE-TX MDI/MDIX Ports	8	16	24
10/100/1000BASE-T MDI/MDIX Ports	2 (Combo)	2	
1000BASE-X SFP/mini-GBIC Slots	2 (Combo)	2	
Switch Architecture	Store-and-Forward		
Switch Fabric	5.6Gbps/ non-blocking	11.2Gbps/ non-blocking	12.8Gbps/ non-blocking
Switch Throughput@64 bytes	4.17Mpps@64 bytes	8.3Mpps@64 bytes	9.5Mpps@64 bytes
MAC Address Table	16K entries	8K entries	
Maximum Frame Size	16K bytes	9216 bytes	
Flow Control	IEEE 802.3x pause frame for full duplex; back pressure for half duplex		
LED Indicators	<p>System: Power (Green)</p> <p>10/100BASE-TX RJ45 Interfaces: 10/100Mbps LNK/ACT (Green) PoE-in-Use (Amber)</p> <p>1000BASE-X SFP Interfaces: LNK/ACT (Green)</p>		
	<p>1000BASE-T TP Interface: LNK/ACT (Green) 1000Mbps (Green)</p>	<p>1000BASE-T TP Interfaces: LNK/ACT (Green) 10Mbps (--) 100Mbps (Red) 1000Mbps (Green)</p>	
LCD Monitor (W x D)	40.6 x 30.5 mm, 2-inch		
Buttons	Menu, Enter, Back, Up and Down		
Dimensions (W x D x H)	180 x 280 x 44mm (1U height)	233 x 440 x 44 mm (1U height)	
Enclosure	Metal		

Weight	1.8kg	3.4kg	3.4kg
Power Requirements	100-240V AC, 50/60Hz, 2.5A max.	100-240V AC, 50/60Hz, 5A max.	
Power Consumption/ Dissipation	Max. 130 watts/ 446 BTU	Max. 330 watts/1132 BTU	
Thermal Fan	1	3	
ESD Protection	Contact discharge of ±4KV DC Air discharge of ±6KV DC	Contact discharge of ±6KV DC Air discharge of ±8KV DC	
Surge Protection	±4KV	±6KV	
Power over Ethernet			
PoE Standard	IEEE 802.3af Power over Ethernet/PSE IEEE 802.3at Power over Ethernet Plus/PSE		
PoE Power Supply Type	End-span		
PoE Power Output	Per port 54V DC, 300mA. max. 15.4 watts (IEEE 802.3af) Per port 54V DC, 600mA. max. 30 watts (IEEE 802.3at)		
Power Pin Assignment	1/2 (+), 3/6 (-)		
PoE Power Budget	120 watts	300 watts	
Max. Number of Class 2 PDs	8	16	24
Max. Number of Class 3 PDs	8	16	23
Max. Number of Class 4 PDs	4	11	11
Standards Conformance			
Regulatory Compliance	FCC Part 15 Class A, CE		
Standards Compliance	IEEE 802.3 10BASE-T IEEE 802.3u 100BASE-TX IEEE 802.3ab Gigabit 1000BASE-T IEEE 802.3z Gigabit SX/LX IEEE 802.3x Flow Control and Back Pressure IEEE 802.3af Power over Ethernet IEEE 802.3at Power over Ethernet Plus IEEE 802.3az Energy Efficient Ethernet (EEE)		



Environment		
Operating	Temperature: 0 ~ 50 degrees C Relative Humidity: 5 ~ 90% (non-condensing)	Temperature: -10 ~ 60 degrees C Relative Humidity: 10 ~ 90% (non-condensing) * Temperature: < 40 degrees C; Humidity: < 90% Temperature: > 40 degrees C; Humidity: < 50%
Storage	Temperature: -10 ~ 70 degrees C Relative Humidity: 5 ~ 90% (non-condensing)	Temperature: -10 ~ 70 degrees C Relative Humidity: 5 ~ 90% (non-condensing)

2. Hardware Description

These switches provide three different running speeds – 10Mbps, 100Mbps and 1000Mbps and automatically distinguish the speed of the incoming connection. This section describes the hardware features of 802.3at PoE+ Switch. For easier management and control of the 802.3at PoE+ Switch, familiarize yourself with its display indicators and ports. Front panel illustrations in this chapter display the unit LED indicators. Before connecting any network device to the 802.3at PoE+ Switch, please read this chapter carefully.

2.1 Front Panel

The front panel of the 802.3at PoE+ Switch consists of 8/16/24 802.3af/at auto-sensing 10/100Mbps Ethernet RJ45 ports and 2 Gigabit TP/SFP ports. The LCD monitor and LED Indicators are also located on the front panel of the 802.3at PoE+ Switch.

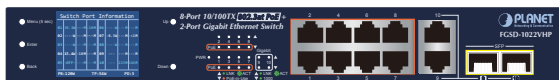

Figure 2-1: FGSD-1022VHP Switch Front Panel



Figure 2-2: FGSW-1822VHP Switch Front Panel



Figure 2-3: FGSW-2622VHP Switch Front Panel

■ Fast Ethernet TP interface

10/100BASE-TX copper, RJ45 twisted-pair: Up to 100 meters.

■ Gigabit TP Interface

10/100/1000BASE-T copper, RJ45 twisted-pair: Up to 100 meters.

■ Gigabit SFP Slots

1000BASE-SX/LX mini-GBIC slot, SFP (Small Factor Pluggable) transceiver module: From 550 meters (multi-mode fiber) to 10/20/40/80/120 kilometers (single-mode fiber).

Smart LCD

The Smart LCD that is located on the front panel of the FGSD-1022VHP, FGSW-1822VHP, FGSW-2622VHP 802.3at PoE+ Switch provides **“PoE Management and Status”, “Switch Mode: Standard, VLAN, Extend”, “Budget and Bandwidth Control”, “Screen Saver”, “Fan Control”, and “Factory Default”**.

2.1.1 LCD Monitor Indicators

The 802.3at PoE+ Switch has an LCD monitor designed for network administrator who can easily obtain real-time per PoE port output watts information and system status display, such as over voltage, low voltage, and PoE chipset over temperature function. The details of each message on the LCD monitor are shown below:

FGSD-1022VHP/FGSW-1822VHP/FGSW-2622VHP LCD Display

Switch Port Information											
01	30.3W	--	--	M	08	--	--	W	--	M	
02	ULP	--	--	M	09	--	--	W	--	M	
03	OLP	--	--	M	10	OFF	--	--	M		
04	SCP	--	--	M	11	--	--	W	--	M	
05		--	--	W	12	--	--	W	--	M	
06	13.6W	--	--	M	13	--	--	W	--	M	
07	14.4W	--	--	M	14	--	--	W	--	M	
PB:300W			TP:0W			PD:3					

PD light load protection — Network traffic
 PD overload protection — PoE OFF
 Short-circuit protection —
 PoE Usage —

Power Budget Total PoE Number of PDs
 Output

Switch Port Information											
01		--	--	W	08	--	--	W	--	M	
02	WARNING!										
03	Main supply voltage is low!										
04	All ports had shut-down.										
05		--	--	W	14	--	--	W	--	M	
07		--	--	W	14	--	--	W	--	M	
PB:300W			TP:0W			PD:0					

Power Low-voltage Protection

Switch Port Information											
01		--	--	W	08	--	--	W	--	M	
02	WARNING!										
03	Main supply voltage is High!										
04	All ports had shut-down.										
05		--	--	W	14	--	--	W	--	M	
07		--	--	W	14	--	--	W	--	M	
PB:300W			TP:0W			PD:0					

Power Over-voltage Protection

Switch Port Information											
01		--	--	W	08	--	--	W	--	M	
02	WARNING!										
03	The PSE device is too hot!										
04	All ports had shut-down.										
05		--	--	W	14	--	--	W	--	M	
07		--	--	W	14	--	--	W	--	M	
PB:300W			TP:0W			PD:0					

PSE Over-temperature Protection



Note

1. The LCD screens of the FGSD-1022VHP and FGSW-1822VHP and FGSW-2622VHP are the same, except the number of ports and port allocation.
2. The LCD screens of the FGSD-1022VHP and FGSW-1822VHP and FGSW-2622VHP will refresh every **15** seconds.
3. For details on LCD Management feature, please refer to **“2.3 LCD Management”**.

■ The detailed Smart LCD description of each item is shown below:

Parameters	Description
30.3W (example)	It means the output power port of the PoE switch.
OLP	It means the port is overloaded corresponding to the PSE, and the port stops powering.
ULP	It means the port corresponding to the PSE is lightly loaded and the port stops powering (When the current on the network is less than 7.5mA, the PSE thinks the PD has been dialed out and the port stops powering).
SCP	It means the port corresponding to the PSE appears to be short-circuited and the port stops powering.
OFF	It means the white and blue OFF shows that the port is blocked by the menu command.
---W	It means the port is without a PD device insert.
---M	It means this port does not have data transfers.
<1M	It means this port data rate transfers less than 1M.
33M (example)	The white and blue character represents the data transmission rate while the red character represents the data transmission rate which is greater than the bandwidth setting, causing power to restart the PSE port. If the resumption situation happens for 10 times within 1 hour, the power supply to the port will be cut off.
PB	It means power budget.
TB	It means total PoE power output information.
PD	The number of PDs inserted.

2.1.2 LED Indicators

■ System

LED	Color	Function
PWR	Green	Lights to indicate that the Switch has power.

■ 10/100Mbps PoE Ports

LED	Color	Function	
LNK/ACT	Green	Lights	Indicates the link through that port is successfully established at 10/100Mbps.
		Blinks	Indicates that the Switch is actively sending or receiving data over that port.
PoE-in-Use	Amber	Lights	Indicates the port is providing DC in-line power.
		Off	Indicates the connected device is not a PoE powered device (PD).

■ 1000Mbps SFP Slots

LED	Color	Function	
LNK/ACT	Green	Lights	Indicates the link through that port is successfully established at 1000Mbps.
		Blinks	Indicates that the Switch is actively sending or receiving data over that port.
1000	Green	Lights	Indicates the port is successfully established at 1000Mbps.

■ 1000Mbps TP Slots (FGSD-1022VHP)

LED	Color	Function	
LNK/ACT	Green	Lights	Indicates the link through that port is successfully established at 1000Mbps.
		Blinks	Indicates that the Switch is actively sending or receiving data over that port.
10/100	--	Dark	Indicates the port is successfully established at 10/100Mbps
1000	Green	Lights	Indicates the port is successfully established at 1000Mbps.

■ 1000Mbps TP Slots (FGSW-1822VHP/FGSW-2622VHP)

LED	Color	Function	
LNK/ACT	Green	Lights	Indicates the link through that port is successfully established at 1000Mbps.
		Blinks	Indicates that the Switch is actively sending or receiving data over that port.
10	--	Dark	Indicates the port is successfully established at 10Mbps.
100	Red	Lights	Indicates the port is successfully established at 100Mbps.
1000	Green	Lights	Indicates the port is successfully established at 1000Mbps.

2.2 Rear Panel

The rear panel of the 802.3at PoE+ Switch has an AC power socket (100-240V AC, 50/60Hz, 2.5/5A max.).



Figure 2-4: FGSD-1022VHP Switch Rear Panel



Figure 2-5: FGSW-1822VHP/FGSW-2622VHP Switch Rear Panel

■ AC Power Receptacle

For compatibility with electrical outlet standard in most areas of the world, the 802.3at PoE+ Switch's power supply automatically adjusts to line power in the range of 100-240V AC, 50/60Hz, 2.5/5A max.

Plug the female end of the power cord firmly into the receptacle on the rear panel of the 802.3at PoE+ Switch and the other end into an electrical outlet, and the power will be ready.



Power Notice

The device is a power-required device, which means it will not work till it is powered. If your networks should be active all the time, please consider using UPS (Uninterrupted Power Supply) for your device. It will prevent you from network data loss or network downtime. In some areas, installing a surge suppression device may also help to protect your 802.3at PoE+ Switch from being damaged by unregulated surge or current to the Switch or the power adapter.

2.3 LCD Management

The operation of the 5 buttons (Menu, Enter, Back, Up and Down) on the panel:

The diagram shows a central LCD display titled "Switch Port Information" with a table of port data. To the left are three buttons: Menu (5 sec), Enter, and Back. To the right are two buttons: Up and Down.

Switch Port Information					
01	30.3W	--M	-33M	08	---
02	---	W	---	09	-8.3W
03	---	W	---	10	---
04	15.4W	-10M	---	11	-OFF-
05	---	W	---	12	---
06	---	W	---	13	17.6W
07	---	W	---	14	---
PB: 300W		TP: 72W		PD: 4	

Press the menu button to switch the "Switch Port Information".

Two screenshots of the "Switch Port Information" LCD display. The first shows ports 01 through 07, and the second shows ports 15 through 28. Both displays show the same data format as the first screenshot, with PB: 300W, TP: 0W, and PD: 0 at the bottom.

Press the menu button for about **5 seconds** and enter the Main Menu. Choose a menu item by scrolling up and down, and press the **"Enter"** key to get to the menu item you have chosen. Press the **"Back"** key to return to the previous menu.

Two screenshots of the "Main Menu" LCD display. The first shows a list of menu items from 01 to 08, and the second shows a list of menu items from 05 to 12. The items are: 01 - Switch Mode, 02 - Budget Control, 03 - PSE Port Priority, 04 - PSE Port Enable, 05 - PD Type, 06 - Alive Check, 07 - Bandwidth, 08 - Fan Control, 05 - PD Type, 06 - Alive Check, 07 - Bandwidth, 08 - Fan Control, 09 - Screen Saver, 10 - Language, 11 - Default Setting, 12 - System.

2.3.1 Switch Mode

There are three modes -- “Standard”, “VLAN” and “Extend” – for selection.

```

Switch Mode

Options:
  > Standard
  VLAN
  Extend

Current Setting: Standard
<UP>/<Down>:Select
<Enter>:Confirm <Back>:Return
    
```

Model	FGSD-1022VHP	FGSW-1822VHP	FGSW-2622VHP
Switch Mode	Function		
Standard (default)	This mode makes the 802.3at PoE+ Switch operate as a general switch and all PoE ports operate at 10/100Mbps auto-negotiation.		
VLAN	This mode makes the FGSD-1022VHP operate as a VLAN isolation switch and 1. Port 1 to port 8 will isolate respectively. 2. Port 1 to port 8 can only communicate with port 9~12 (uplink port).	This mode makes the FGSW-1822VHP operate as a VLAN isolation switch and 1. Port 1 to port 16 will isolate respectively. 2. Port 1 to port 16 can only communicate with port 17~20 (uplink port).	This mode makes the FGSW-2622VHP operate as a VLAN isolation switch and 1. Port 1 to port 24 will isolate respectively. 2. Port 1 to port 24 can only communicate with port 25~28 (uplink port).
Extend with VLAN Isolation	This mode makes the FGSD-1022VHP operate as a VLAN isolation switch and 1. Port 1 to port 8 will isolate respectively. 2. Port 1 to port 8 can only communicate with port 9~12 (uplink port). 3. 20-watt PoE transmit distance of 250m at speed of 10Mbps.	This mode makes the FGSW-1822VHP operate as a VLAN isolation switch and 1. Port 1 to port 16 will isolate respectively. 2. Port 1 to port 16 can only communicate with port 17~20 (uplink port). 3. 20-watt PoE transmit distance of 250m at speed of 10Mbps.	This mode makes the FGSW-2622VHP operate as a VLAN isolation switch and 1. Port 1 to port 24 will isolate respectively. 2. Port 1 to port 24 can only communicate with port 25~28 (uplink port). 3. 20-watt PoE transmit distance of 250m at speed of 10Mbps.

Table 2-1: FGSD/FGSW 802.3at PoE+ Switch Description

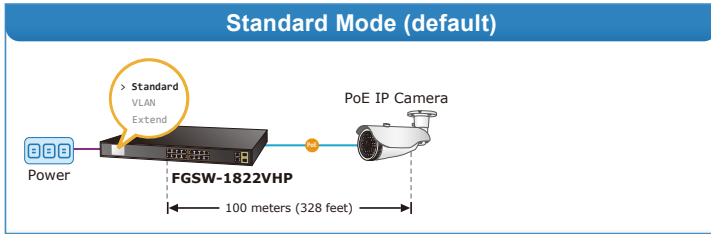

100BASE-TX UTP with PoE

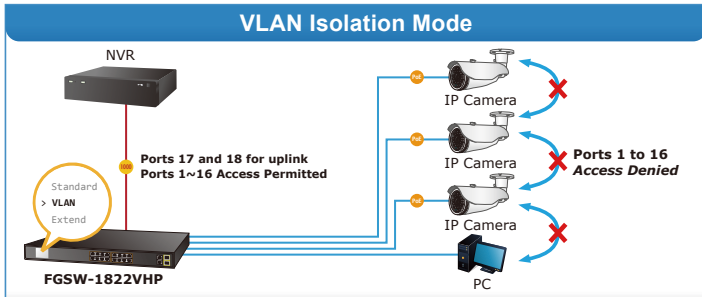

—●— 1000BASE-SX/LX Fiber-optic
—●— 100BASE-TX UTP
—●— 100BASE-TX UTP with PoE

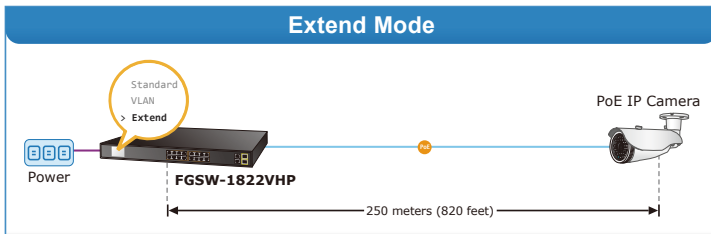

10BASE-T UTP with PoE

VLAN Isolation Feature

The 802.3at PoE+ Switch has one feature called VLAN function. When switching the mode to the **"VLAN"** position, port 1 to port 8/16/24 wouldn't able to communicate with each other.

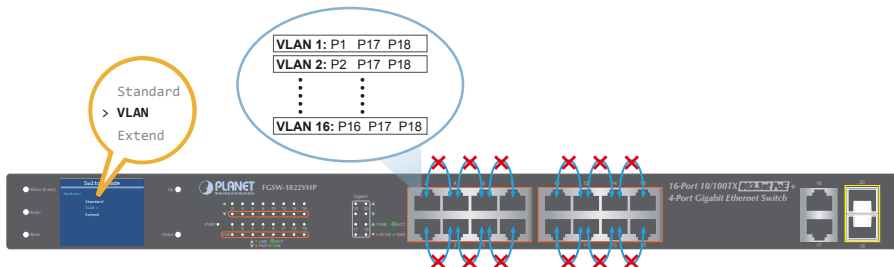

2.3.2 Budget Control

Due to the power allocation strategy of PSE, when the residual power of PoE is too large, the power distribution of the port can be increased as much as possible by increasing the power trimming of the PSE, so that the utilization of the PSE power supply can be improved. There are four levels of budget control named **Unchanged (default)**, **Add 5% PB**, **Add 10% PB** and **Add 15% PB**.

```
Budget Control
-----
Options:
  > Unchanged
    Add  5% PB
    Add 10% PB
    Add 15% PB
Current Setting: Unchanged
<UP>/<Down>:Select
<Enter>:Confirm <Back>:Return
```



1. The default PoE budget is 120W/300W in unchanged mode. If you hope to have a full load of over 120W/300W, please select Add 5% PB, Add 10% PB and Add 15 % PB.
2. In order to make sure the PSE power supply is not overloaded for a long time, please try to ensure that TP is less than PB.

2.3.3 PSE Port Priority

he Priority represents PoE ports priority. There are three levels of power priority named Low, High and Critical. The priority is used in case the total power consumption is over the total power budget. In this case the port with the lowest priority will be turned off, and offer power for the port of higher priority. The default port priority is **“Low”**.

```
PSE Port Priority
-----
Port      Priority
  01      Critical
          High
          > Low
Current Setting: LOW
<UP>/<Down>:Select
<Enter>:Confirm <Back>:Return
```

2.3.4 PSE Port Enable

Allows user to disable or enable per port PoE function. The default is "Enable".

```
PSE Port Enable

Port      Status
 01      > Enable
          Disable

Current Setting: Enable
<UP>/<Down>:Select
<Enter>:Confirm <Back>:Return
```

2.3.5 PD Type

Changing the PoE power-up mode can let non-standard PDs pass the procedures of PoE power delivery process. This way, the switch can supply power to non-standard PDs. The FGSD/FGSW 802.3at PoE+ Switch series can set the PoE power-up mode to be in Enhance mode, Standard mode or Legacy mode by the user interface.

```
PD Type

Options:
  > Enhance
    Standard
    Legacy

Current Setting: Enhance
<UP>/<Down>:Select
<Enter>:Confirm <Back>:Return
```

Object	Description
Enhance (default)	On the basis of standard mode, change the PD of class 0 to AT mode; in addition, the current surge limit during power up increases to the current limit of AT.
Standard	Fully conforms to the IEEE 802.3af/at standard.
Legacy	The legacy detection is to identify the PD devices that did not follow the IEEE 802.3af standard and their unique electrical signatures, in order for the PoE switch to provide the power to those PD devices.

2.3.6 Alive Check

The FGSD/FGSW 802.3at PoE+ Switch series can be configured to monitor connected PD's status in real time via traffic detection. Once there is no traffic at interval time, the FGSD/FGSW 802.3at PoE+ Switch series is going to restart PoE port power, and bring the PD back to work. It will greatly enhance the reliability and reduce administrator management burden.

Alive Check		
Port	Status	
01	Disable	
Startup	Interval	PowerOff
180	180	5
<UP>/<Down>:Select		
<Enter>:Confirm <Back>:Return		

Object	Description
Port	Select the port number to enable Alive Check.
Status	Allows user to enable or disable per port PD Alive Check function. All ports are disabled as default value.
Startup Time (60~300s)	PD startup time This startup time is based on determining when to start to measure the traffic. The default startup time is 180 seconds.
Interval Time (60~300s)	Traffic detection counter The switch detects no traffic during this time and countdown for interval time begins and port begins to reboot. The default interval time is 180 seconds.
Power Off (5~60s)	PoE Port Disable Timer This column allows user to set the PoE device rebooting time. The default power off time is 5 seconds.

The PD Alive Check is not a defining standard, so the PoE device on the market doesn't report reboots done information to the PoE Switch. So user has to make sure how long it takes for the PD to finish booting, and then set the time value related column. The system is going to check the PD again according to the reboot time. If you cannot make sure the precise booting time, we suggest you set it longer.

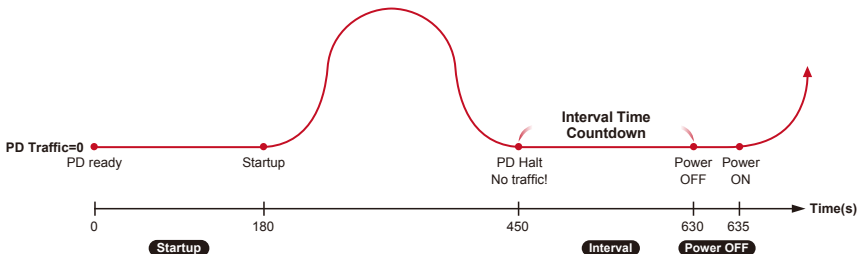

Figure 2-4: Alive Check Mechanism

2.3.7 Bandwidth Detection

When the network transmits “the highest data rate”, more than the set value, over a single port, the switch will set off an alarm to warn the overuse of the bandwidth. There are four levels of budget control, namely **Unlimited (default)**, **70Mbps**, **80Mbps** and **90Mbps**.

```
Bandwidth Detection
Options:
  > Unlimited
    70Mbps
    80Mbps
    90Mbps
Current Setting: Unlimited
<UP>/<Down>:Select
<Enter>:Confirm <Back>:Return
```

2.3.8 Fan Control

Fan control is to achieve the set power with intelligent operation. There are four levels of budget control, namely **Always ON**, **20% PB (default)**, **40% PB** and **60% PB**.

```
Fan Control
Options:
  > Always ON
    20% PB
    40% PB
    60% PB
Current Setting: Always ON
<UP>/<Down>:Select
<Enter>:Confirm <Back>:Return
```

2.3.9 Screen Saver

There are four levels of budget control, namely **Always ON**, **10min (default)**, **20min** and **30min**.

```
Screen Saver
LCD Idle Time:
  > Always On
    10min
    20min
    30min
Current Setting: Always ON
<UP>/<Down>:Select
<Enter>:Confirm <Back>:Return
```

2.3.10 Language

There are two languages, namely **English** and **Chinese**.

```
Language
-----
Options:
  > English
    Chinese

Current Setting: English
<UP>/<Down>:Select
<Enter>:Confirm <Back>:Return
```

2.3.11 Default Setting

Restore the device to default.

```
Default Setting
-----

System restore
setting...
```

2.3.12 System

Show the system information.

```
System
-----

PLANET 802.3af/at PoE Switch

Model: FGSW-2622VHP
HW ver: V3.0
SW ver: V1.25

www.planet.com.tw

<Back>: Return
```

3. Hardware Installation

Start up

Please refer to the following for your cabling:

10/100BASE-TX

All 10/100BASE-TX ports come with Auto-Negotiation capability. They automatically support 100BASE-TX and 10BASE-T networks. Users only need to plug a working network device into one of the 10/100BASE-TX ports, and then turn on the 802.3at PoE+ Switch. The port will automatically run at 10Mbps, 20Mbps, 100Mbps or 200Mbps after the negotiation with the connected device.

10/100/1000BASE-T

All 10/100/1000BASE-T ports come with Auto-Negotiation capability. They automatically support 1000BASE-T, 100BASE-TX and 10BASE-T networks. Users only need to plug a working network device into one of the 10/100/1000BASE-T ports, and then turn on the 802.3at PoE+ Switch. The port will automatically run at 10Mbps, 20Mbps, 100Mbps or 200Mbps and 1000Mbps or 2000Mbps after negotiating with the connected device.

Cabling

Each 10/100BASE-TX port and 10/100/1000BASE-T port uses RJ45 sockets -- similar to phone jacks -- for connection of unshielded twisted-pair cable (UTP). The IEEE 802.3/802.3u/802.3ab Fast/Gigabit Ethernet standard requires Category 5 UTP for 100Mbps 100BASE-TX. 10BASE-T networks can use Cat.3, 4, 5 or 1000BASE-T uses 5/5e/6 UTP (see table below). Maximum distance is 100 meters (328 feet).

Port Type	Cable Type	Connector
10BASE-T	Cat.3, 4, 5, 2-pair	RJ45
100BASE-TX	Cat.5, 5e UTP, 4-pair	RJ45
1000BASE-T	Cat.5/5e/6 UTP, 4-pair	RJ45

Any Ethernet devices like hubs/PCs can connect to the 802.3at PoE+ Switch by using straight-through wires. The whole 10/100/1000Mbps ports are auto-MDI/MDI-X that can be used on straight-through or crossover cable.

3.1 Desktop Installation

To install the 802.3at PoE+ Switch on desktop, simply follow the following steps:

Step 1: Attach the rubber feet to the recessed areas on the bottom of the 802.3at PoE+ Ethernet Switch, as shown in Figure 3-1.

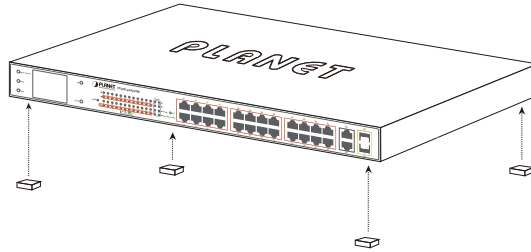

Figure 3-1: Attaching the Rubber Feet to the 802.3at PoE+ Switch

Step 2: Place the 802.3at PoE+ Switch on desktop near an AC power source.

Step 3: Keep enough ventilation space between the 802.3at PoE+ Switch and the surrounding object.



Note

When choosing a location, please keep in mind the environmental restrictions discussed in Chapter 1, Section 4, under Specifications.

Step 4: Connect your 802.3at PoE+ Switch to 802.3af/802.3at complied power devices (PDs) and other network devices.

- A.** Connect one end of a standard network cable to the 10/100BASE-TX RJ45 ports on the front panel of the 802.3at PoE+ Switch.
- B.** Connect the other end of the cable to the network devices such as printer servers, workstations or routers, etc.



Note

Connection to the Switch requires UTP Category 5, 5e, 6 network cabling with RJ45 tips. For more information, please see the Cabling Specification in Appendix A.

Step 5: Supply power to the 802.3at PoE+ Switch.

- A.** Connect one end of the power cable to the 802.3at PoE+ Switch.
- B.** Connect the power plug of the power cable to a standard wall outlet.

When the 802.3at PoE+ Switch receives power, the Power LED should remain solid Green.

3.2 Rack Mounting

To install the 802.3at PoE+ Switch in a 19-inch standard rack, follow the instructions described below.

Step 1: Place your 802.3at PoE+ Switch on a hard flat surface, with the front panel positioned towards your front side.

Step 2: Attach a rack-mount bracket to each side of the 802.3at PoE+ Switch with supplied screws attached to the package. Figure 3-2 shows how to attach brackets to one side of the 802.3at PoE+ Switch

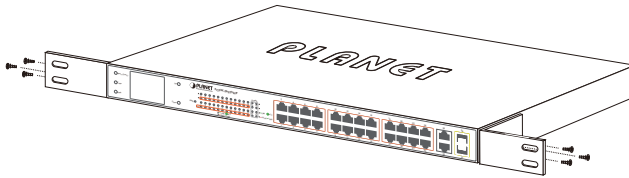

Figure 3-2: Attaching the Brackets to the 802.3at PoE+ Switch



You must use the screws supplied with the mounting brackets. Damage caused to the parts by using incorrect screws would invalidate the warranty.

Step 3: Secure the brackets tightly.

Step 4: Follow the same steps to attach the second bracket to the opposite side.

Step 5: After the brackets are attached to the 802.3at PoE+ Switch, use suitable screws to securely attach the brackets to the rack, as shown in Figure 3-3.

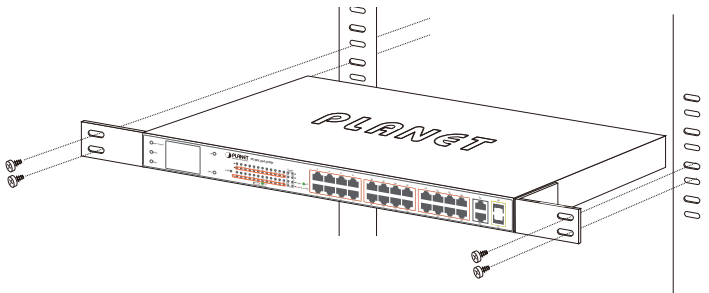

Figure 3-3: Mounting the 802.3at PoE+ Switch in a Rack

Step 6: Proceed with Steps 4 and 5 of **session 3.1 Desktop Installation** to connect the network cabling and supply power to your Switch.

3.3 Installing the SFP Transceiver

The sections describe how to insert an SFP transceiver into an SFP slot of the 802.3at PoE+ Switch. The SFP transceivers are hot-pluggable and hot-swappable. You can plug in and out the transceiver to/from any SFP port without having to power down the 802.3at PoE+ Switch, as the Figure 3-4 shows.

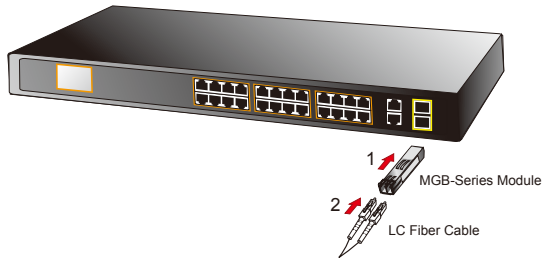

Figure 3-4: Plugging in the SFP Transceiver

■ Approved PLANET SFP Transceivers

PLANET 802.3at PoE+ Switch supports both single mode and multi-mode SFP transceivers. The following list of approved PLANET SFP transceivers is correct at the time of publication:

Gigabit SFP Transceiver Modules

- MGB-GT SFP-Port 1000BASE-T Module
- MGB-SX SFP-Port 1000BASE-SX mini-GBIC module - 550m
- MGB-SX2 SFP-Port 1000BASE-SX mini-GBIC module - 2km
- MGB-LX SFP-Port 1000BASE-LX mini-GBIC module - 20km
- MGB-L40 SFP-Port 1000BASE-LX mini-GBIC module - 40km
- MGB-L80 SFP-Port 1000BASE-LX mini-GBIC module - 80km
- MGB-L120 SFP-Port 1000BASE-LX mini-GBIC module - 120km
- MGB-LA10 SFP-Port 1000BASE-LX (WDM, TX:1310nm) - 10km
- MGB-LB10 SFP-Port 1000BASE-LX (WDM, TX:1550nm) - 10km
- MGB-LA20 SFP-Port 1000BASE-LX (WDM, TX:1310nm) - 20km
- MGB-LB20 SFP-Port 1000BASE-LX (WDM, TX:1550nm) - 20km
- MGB-LA40 SFP-Port 1000BASE-LX (WDM, TX:1310nm) - 40km
- MGB-LB40 SFP-Port 1000BASE-LX (WDM, TX:1550nm) - 40km
- MGB-LA80 SFP-Port 1000BASE-LX (WDM, TX:1490nm) - 80km
- MGB-LB80 SFP-Port 1000BASE-LX (WDM, TX:1550nm) - 80km



Note

It is recommended to use PLANET SFP on the 802.3at PoE+ Switch. If you insert an SFP transceiver that is not supported, the 802.3at PoE+ Switch will not recognize it..

1. Before we connect the 802.3at PoE+ Switch to the other network device, we have to make sure both sides of the SFP transceivers are with the same media type, for example, 1000BASE-SX to 1000BASE-SX; 1000BASE-LX to 1000BASE-LX.
2. Check whether the fiber-optic cable type matches with the SFP transceiver requirement.
 - To connect to 1000BASE-SX SFP transceiver, please use the multi-mode fiber cable with one side being the male duplex LC connector type.
 - To connect to 1000BASE-LX SFP transceiver, please use the single-mode fiber cable with one side being the male duplex LC connector type.

■ Connect the Fiber Cable

1. Insert the duplex LC connector into the SFP transceiver.
2. Connect the other end of the cable to a device with SFP transceiver installed.
3. Check the LNK/ACT LED of the SFP slot on the front of the 802.3at PoE+ Switch. Ensure that the SFP transceiver is operating correctly.

■ Remove the Transceiver Module

1. Make sure there is no network activity anymore.
2. Remove the Fiber-Optic Cable gently.
3. Lift up the lever of the MGB module and turn it to a horizontal position.
4. Pull out the module gently through the lever, as Figure 3-5 shows.

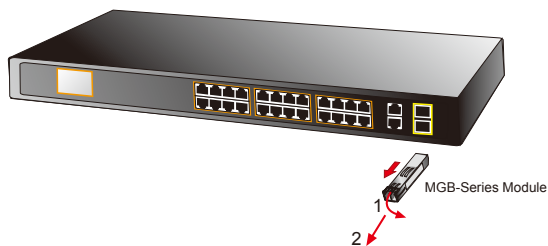

Figure 3-5: How to Pull Out the SFP Transceiver



Note

Never pull out the module without lifting up the lever of the module and turning it to a horizontal position. Directly pulling out the module could damage the module and the SFP module slot of the 802.3at PoE+ Switch.

3.4 Product Applications

Department/Workgroup PoE Switch:

Providing 8/16/24 PoE in-line power interfaces, the 802.3at PoE+ Switch can easily build a power that centrally controls IP phone system, IP camera system and wireless AP group for enterprises. Cameras can be installed around the corner in the company or campus for surveillance demands. Without the power-socket limitation, the 802.3at PoE+ Switch makes the installation of cameras easier and more efficient.

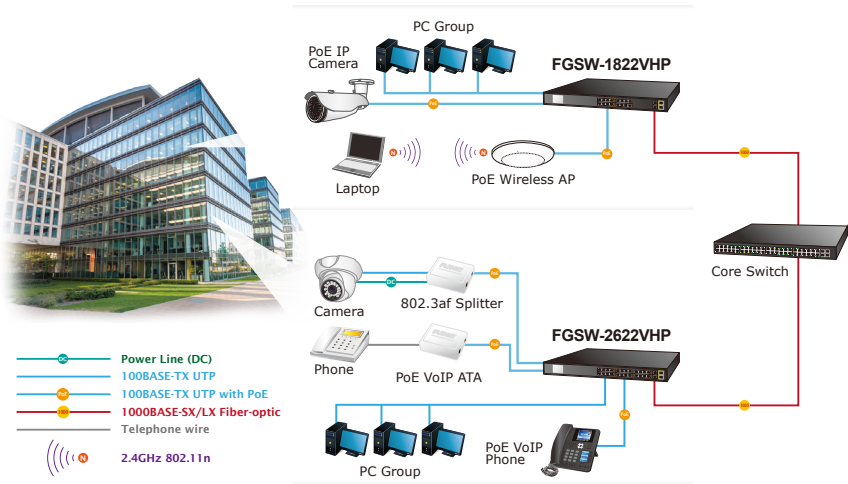







Figure 3-6: Department/Workgroup 802.3at PoE+ Switch Connection

3.5 Power over Ethernet Powered Devices

 <p>3~5 watts</p>	<p>Voice over IP Phones</p> <p>As many as PoE VoIP phones, ATAs and other Ethernet/non-Ethernet end-devices can be installed, but UPS is needed for uninterrupted power system and power control system.</p>
 <p>6~12 watts</p>	<p>Wireless LAN Access Points</p> <p>Access points can readily be installed in museums, sightseeing sites, airports, hotels, campuses, factories and warehouses.</p>
 <p>10~12 watts</p>	<p>IP Surveillance</p> <p>For the sake of security, install IP cameras around enterprises, museums, campuses, hospitals and bank without considering location and electrical outlets.</p>
 <p>3~12 watts</p>	<p>PoE Splitter</p> <p>As PoE Splitter splits the PoE 48V DC over the Ethernet cable into 5/12V DC power output, network deployments can easily be made without worrying about power outlet locations, thus eliminating the costs for additional AC wiring and reducing the installation time.</p>
 <p>3~25 watts</p>	<p>High Power PoE Splitter</p> <p>As PoE Splitter splits the PoE 53V-54V DC over the Ethernet cable into 24/12V DC power output, network deployments can easily be made without worrying about power outlet locations, thus eliminating the costs for additional AC wiring and reducing the installation time.</p>
 <p>30 watts</p>	<p>High Power Speed Dome</p> <p>This state-of-the-art design fits very nicely in various network environments like traffic centers, shopping malls, railway stations, warehouses, airports and production facilities for the most the demanding outdoor surveillance applications. Electrician is not needed to install AC sockets.</p>



Since each port of the 802.3at PoE+ Switch supports 52V-54 DC PoE power output, please make sure the PD's acceptable DC power range is from 52V-54 DC. Otherwise, it will damage the PD.

4. Power over Ethernet Overview

What is PoE?

PoE is an abbreviation of Power over Ethernet. The PoE technology means a system safely transmits both power and data on Ethernet UTP cable. The IEEE standard for PoE technology requires Category 5 cable or higher for high power PoE levels, but can operate with Cat3 cable for low power levels. Power is supplied in common mode over two or more of the differential pairs of wires found in the Ethernet cables and comes from a power supply within a PoE-enabled network device such as an Ethernet switch or can be injected into a cable run with a mid-span power supply.

The original IEEE 802.3af-2003 PoE standard provides up to 15.4W of DC power (minimum 44V DC and 350mA) to each device. Only 12.95W is assured to be available at the powered device as some power is dissipated in the cable.

The updated IEEE 802.3at-2009 PoE standard, also known as PoE+ or PoE plus, provides up to 25.5W of power. The 2009 standard prohibits a powered device from using all four pairs for power.

The 802.3af/802.3at defines two types of source equipment: mid-span and end-span.

➤ Mid-span

Mid-span device is placed between legacy switch and the powered device. Mid-span taps the unused wire pairs 4/5 and 7/8 to carry power; the other four are for data transmit.

➤ End-span

End-span device is directly connected with power device. End-span could also tap the wire 1/2 and 3/6.

➤ PoE System Architecture

The specification of PoE typically requires two devices: the Powered Source Equipment (PSE) and the Powered Device (PD). The PSE is either an end-span or a mid-span, while the PD is a PoE-enabled terminal, such as IP phones, wireless LAN, etc. Power can be delivered over data pairs or spare pairs of standard Cat5 cabling.

➤ Powered Source Equipment (PSE)

Power sourcing equipment (PSE) is a device such as a switch that provides (sources) power on the Ethernet cable. The maximum allowed for continuous output power per cable in IEEE 802.3af is 15.4W. A later specification, IEEE 802.3at, offers 25.50W. When the device is a switch, it is commonly called an end-span (although IEEE 802.3af refers to it as endpoint). Otherwise, if it is an

intermediary device between a non-PoE capable switch and a PoE device, it is called a mid-span. An external PoE injector is a mid-span device.

➤ **Powered Device**

A powered device (PD) is a device powered by a PSE and thus consumes energy. Examples include wireless access points, IP phones, and IP cameras. Many powered devices have an auxiliary power connector for an optional, external power supply. Depending on the PD design, some, none, or all power can be supplied from the auxiliary port, with the auxiliary port sometimes acting as backup power in case of PoE supplied power failure.

➤ **How Power is Transferred through Cable**

A standard Cat5 Ethernet cable has four twisted pairs, but only two of these are used for 10BASE-T and 100BASE-TX. The specification allows two options for using these cables for power, shown in Figure 1 and Figure 2:

The spare pairs are used. Figure 1 shows the pair on pins 4 and 5 connected together and forming the positive supply, and the pair on pins 7 and 8 connected together and forming the negative supply. (In fact, a late change to the spec allows either polarity to be used).

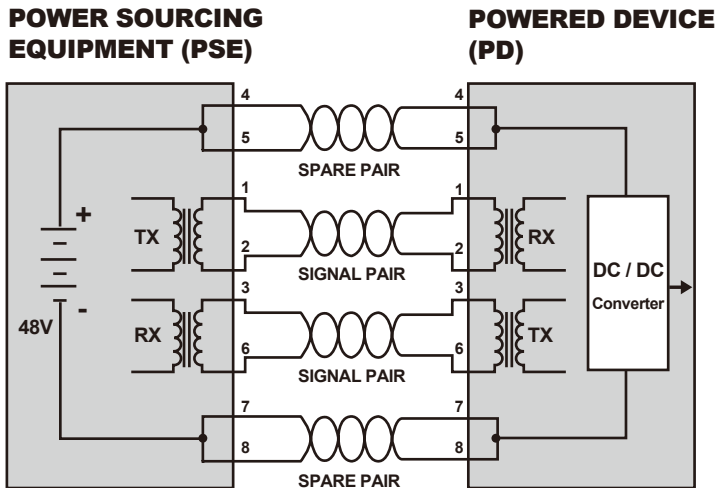

Figure 1: Power Supplied over Spare Pins

The data pairs are used. Since Ethernet pairs are transformers coupled at each end, it is possible to apply DC power to the center tap of the isolated transformer without upsetting the data transfer. In this mode of operation, the pair on pins 3 and 6 and the pair on pins 1 and 2 can be of either polarity.

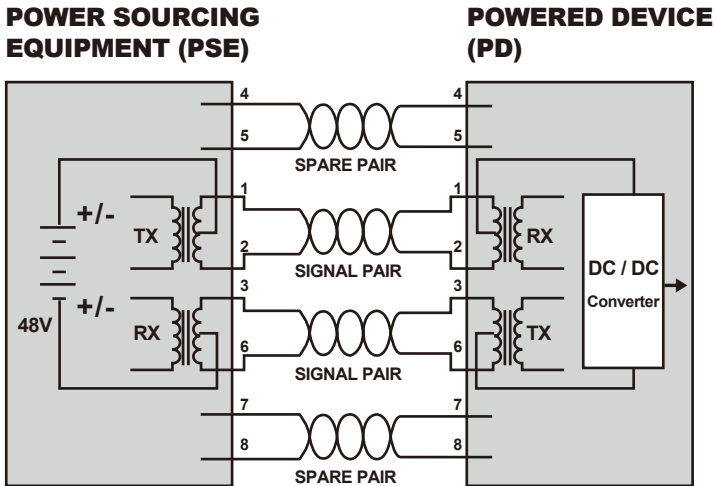

Figure 2: Power Supplied over Data Pins

➤ When to install PoE

Consider the following scenarios:

- You're planning to install the latest VoIP phone system to minimize cabling building costs when your company moves into a new office next month.
- The company staff has been clamoring for a wireless access point in the picnic area behind the building so they can work on their laptops through lunch, but the cost of electrical power to the outside is not affordable.
- Management asks for IP Surveillance Cameras and business access systems throughout the facility, but they would rather avoid another electrician's payment.

5. Troubleshooting

This chapter contains information to help you solve issues. If the 802.3at PoE+ Switch is not functioning properly, make sure the 802.3at PoE+ Switch was set up according to instructions in this manual.

The Link LED is not lit.

Solution:

Check the cable connection and also try to swap one new cable.

LNK/ACT link LED is lit, but the traffic is irregular.

Solution:

Make sure the attached device is not set to full duplex. Some devices use a physical or software switch to change duplex modes. Auto-negotiation may not recognize this type of full-duplex setting.

Why the Switch doesn't connect to the network.

Solution:

Check the LNK/ACT LED on the 802.3at PoE+ Switch. Try another port on the 802.3at PoE+ Switch. Make sure the cable is installed properly. Make sure the cable is the right type. Turn off the power. After a while, turn on the power again.

Why the FGSD/FGSW Switch, connected to PoE device, cannot be powered on.

Solution:

1. Please check the cable type of the connection from FGSD/FGSW switch to the other end. The cable should be an 8-wire UTP, Category 5 or above and EIA568 cable within 100 meters. A cable with only 4-wire, short loop or over 100 meters will affect the power supply.
2. Please make sure the device is fully complied with IEEE 802.3af/IEEE 802.3at standard.

What is the power output of each PoE port?

Solution:

1. Each PoE port supports **54 DC, 600mA** and a **maximum of 30 watts** of power output. Detect and inject by the standard of IEEE 802.3at.
2. Each PoE port supports **54 DC, 300mA** and a **maximum of 15.4 watts** of power output. Detect and inject by the standard of IEEE 802.3af.

EC Declaration of Conformity

For the following equipment:

*Type of Product : 8-Port 10/100TX 802.3at PoE + 2-Port Gigabit TP/SFP combo Desktop Switch
with LCD PoE Monitor (120 Watts)

*Model Number : FGSD-1022VHP

* Produced by:

Manufacturer's Name : **Planet Technology Corp.**

Manufacturer's Address : 10F., No.96, Minquan Rd., Xindian Dist., New Taipei City 231, Taiwan

is herewith confirmed to comply with the requirements set out in the Council Directive on the Approximation of the Laws of the Member States relating to Electromagnetic Compatibility Directive 2014/30/EU.

For the evaluation regarding the EMC, the following standards were applied:

EN 55032	2015+AC:2016 Class A
AS/NZS CISPR 32	2015 Class A
EN 61000-3-2	2014 Class A
EN 61000-3-3	2013
EN 55035	2017
EN 60950-1	2006+A11:2009+A1:2010+A12:2011+A2:2013

Responsible for marking this declaration if the:

Manufacturer Authorized representative established within the EU

Authorized representative established within the EU (if applicable):

Company Name: **Planet Technology Corp.**

Company Address: **10F., No.96, Minquan Rd., Xindian Dist., New Taipei City 231, Taiwan**

Person responsible for making this declaration

Name, Surname : **Jonas Yang**

Position / Title : **Product Manager**

Taiwan
Place

Nov. 29th, 2018
Date

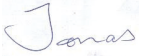
Legal Signature

PLANET TECHNOLOGY CORPORATION

e-mail: sales@planet.com.tw <http://www.planet.com.tw>

10F., No.96, Minquan Rd., Xindian Dist., New Taipei City, Taiwan [Tel:886-2-2219-9518](tel:886-2-2219-9518) Fax:886-2-2219-9528

EC Declaration of Conformity

For the following equipment:

*Type of Product : 16/24-Port 10/100TX 802.3at PoE + 2-Port Gigabit TP/SFP Combo Ethernet Switch with LCD PoE Monitor (300W)

*Model Number : FGSW-1822VHP, FGSW-2622VHP

* Produced by:

Manufacturer's Name : **Planet Technology Corp.**

Manufacturer's Address : 10F., No.96, Minquan Rd., Xindian Dist., New Taipei City 231, Taiwan

is herewith confirmed to comply with the requirements set out in the Council Directive on the Approximation of the Laws of the Member States relating to Electromagnetic Compatibility Directive 2014/30/EU.

For the evaluation regarding the EMC, the following standards were applied:

EN 55032	2015 Class A
AS/NZS CISPR 32	2015
EN 61000-3-2	2014 Class A
EN 61000-3-3	2013
EN 55024	2010+A1:2015

Responsible for marking this declaration if the:

Manufacturer Authorized representative established within the EU

Authorized representative established within the EU (if applicable):

Company Name: Planet Technology Corp.

Company Address: 10F., No.96, Minquan Rd., Xindian Dist., New Taipei City 231, Taiwan

Person responsible for making this declaration

Name, Surname : Jonas Yang

Position / Title : Director

Taiwan
Place

Jun 14th, 2018
Date

Legal Signature

PLANET TECHNOLOGY CORPORATION